

**75A, 60V, 0.0075 Ohm, N-Channel, Logic Level UltraFET® Power MOSFET**



**Packaging**

JEDEC TO-220AB

JEDEC TO-263AB

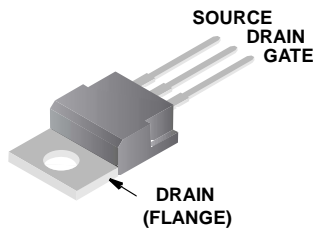

HUF76445P3

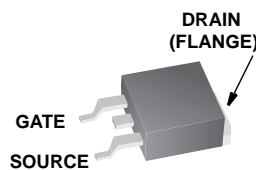

HUF76445S3S

**Symbol**

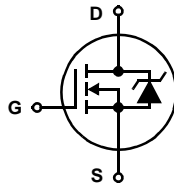

**Features**

- Ultra Low On-Resistance
  - $r_{DS(ON)} = 0.0065\Omega, V_{GS} = 10V$
  - $r_{DS(ON)} = 0.0075\Omega, V_{GS} = 5V$
- Simulation Models
  - Temperature Compensated PSpice® and SABER™ Electrical Models
  - Spice and SABER Thermal Impedance Models
  - [www.fairchildsemi.com](http://www.fairchildsemi.com)
- Peak Current vs Pulse Width Curve
- UIS Rating Curve
- Switching Time vs  $R_{GS}$  Curves

**Ordering Information**

PART NUMBER	PACKAGE	BRAND
HUF76445P3	TO-220AB	76445P
HUF76445S3S	TO-263AB	76445S

NOTE: When ordering, use the entire part number. Add the suffix T to obtain the variant in tape and reel, e.g., HUF76445S3ST.

**Absolute Maximum Ratings**  $T_C = 25^\circ C$ , Unless Otherwise Specified

	HUF76445P3, HUF76445S3S	UNITS
Drain to Source Voltage (Note 1).....	$V_{DSS}$	60 V
Drain to Gate Voltage ( $R_{GS} = 20k\Omega$ ) (Note 1).....	$V_{DGR}$	60 V
Gate to Source Voltage.....	$V_{GS}$	$\pm 16$ V
Drain Current		
Continuous ( $T_C = 25^\circ C, V_{GS} = 5V$ ).....	$I_D$	75 A
Continuous ( $T_C = 25^\circ C, V_{GS} = 10V$ ) (Figure 2).....	$I_D$	75 A
Continuous ( $T_C = 100^\circ C, V_{GS} = 5V$ ).....	$I_D$	75 A
Continuous ( $T_C = 100^\circ C, V_{GS} = 4.5V$ ) (Figure 2).....	$I_D$	75 A
Pulsed Drain Current.....	$I_{DM}$	Figure 4
Pulsed Avalanche Rating.....	UIS	Figures 6, 17, 18
Power Dissipation.....	$P_D$	310 W
Derate Above $25^\circ C$ .....		2.08 $W/^\circ C$
Operating and Storage Temperature.....	$T_J, T_{STG}$	-55 to 175 $^\circ C$
Maximum Temperature for Soldering		
Leads at 0.063in (1.6mm) from Case for 10s.....	$T_L$	300 $^\circ C$
Package Body for 10s, See Techbrief TB334.....	$T_{pkg}$	260 $^\circ C$

NOTES:

1.  $T_J = 25^\circ C$  to  $150^\circ C$ .

**CAUTION:** Stresses above those listed in "Absolute Maximum Ratings" may cause permanent damage to the device. This is a stress only rating and operation of the device at these or any other conditions above those indicated in the operational sections of this specification is not implied.

Product reliability information can be found at <http://www.fairchildsemi.com/products/discrete/reliability/index.html>

For severe environments, see our Automotive HUFA series.

All Fairchild semiconductor products are manufactured, assembled and tested under ISO9000 and QS9000 quality systems certification.

# HUF76445P3, HUF76445S3S

## Electrical Specifications $T_C = 25^\circ\text{C}$ , Unless Otherwise Specified

PARAMETER	SYMBOL	TEST CONDITIONS	MIN	TYP	MAX	UNITS	
<b>OFF STATE SPECIFICATIONS</b>							
Drain to Source Breakdown Voltage	$BV_{DSS}$	$I_D = 250\mu\text{A}$ , $V_{GS} = 0\text{V}$ (Figure 12)	60	-	-	V	
		$I_D = 250\mu\text{A}$ , $V_{GS} = 0\text{V}$ , $T_C = -40^\circ\text{C}$ (Figure 12)	55	-	-	V	
Zero Gate Voltage Drain Current	$I_{DSS}$	$V_{DS} = 55\text{V}$ , $V_{GS} = 0\text{V}$	-	-	1	$\mu\text{A}$	
		$V_{DS} = 50\text{V}$ , $V_{GS} = 0\text{V}$ , $T_C = 150^\circ\text{C}$	-	-	250	$\mu\text{A}$	
Gate to Source Leakage Current	$I_{GSS}$	$V_{GS} = \pm 16\text{V}$	-	-	$\pm 100$	nA	
<b>ON STATE SPECIFICATIONS</b>							
Gate to Source Threshold Voltage	$V_{GS(TH)}$	$V_{GS} = V_{DS}$ , $I_D = 250\mu\text{A}$ (Figure 11)	1	-	3	V	
Drain to Source On Resistance	$r_{DS(ON)}$	$I_D = 75\text{A}$ , $V_{GS} = 10\text{V}$ (Figures 9, 10)	-	0.0054	0.0065	$\Omega$	
		$I_D = 75\text{A}$ , $V_{GS} = 5\text{V}$ (Figure 9)	-	0.0063	0.0075	$\Omega$	
		$I_D = 75\text{A}$ , $V_{GS} = 4.5\text{V}$ (Figure 9)	-	0.0066	0.008	$\Omega$	
<b>THERMAL SPECIFICATIONS</b>							
Thermal Resistance Junction to Case	$R_{\theta JC}$	TO-220 and TO-263	-	-	0.48	$^\circ\text{C/W}$	
Thermal Resistance Junction to Ambient	$R_{\theta JA}$		-	-	62	$^\circ\text{C/W}$	
<b>SWITCHING SPECIFICATIONS (<math>V_{GS} = 4.5\text{V}</math>)</b>							
Turn-On Time	$t_{ON}$	$V_{DD} = 30\text{V}$ , $I_D = 75\text{A}$ $V_{GS} = 4.5\text{V}$ , $R_{GS} = 2.2\Omega$ (Figures 15, 21, 22)	-	-	515	ns	
Turn-On Delay Time	$t_{d(ON)}$		-	18	-	ns	
Rise Time	$t_r$		-	325	-	ns	
Turn-Off Delay Time	$t_{d(OFF)}$		-	39	-	ns	
Fall Time	$t_f$		-	135	-	ns	
Turn-Off Time	$t_{OFF}$		-	-	260	ns	
<b>SWITCHING SPECIFICATIONS (<math>V_{GS} = 10\text{V}</math>)</b>							
Turn-On Time	$t_{ON}$	$V_{DD} = 30\text{V}$ , $I_D = 75\text{A}$ $V_{GS} = 10\text{V}$ , $R_{GS} = 2.4\Omega$ (Figures 16, 21, 22)	-	-	205	ns	
Turn-On Delay Time	$t_{d(ON)}$		-	12	-	ns	
Rise Time	$t_r$		-	126	-	ns	
Turn-Off Delay Time	$t_{d(OFF)}$		-	62	-	ns	
Fall Time	$t_f$		-	135	-	ns	
Turn-Off Time	$t_{OFF}$		-	-	295	ns	
<b>GATE CHARGE SPECIFICATIONS</b>							
Total Gate Charge	$Q_{g(TOT)}$	$V_{GS} = 0\text{V}$ to $10\text{V}$	$V_{DD} = 30\text{V}$ , $I_D = 75\text{A}$ , $I_{g(REF)} = 1.0\text{mA}$ (Figures 14, 19, 20)	-	124	150	nC
Gate Charge at 5V	$Q_{g(5)}$	$V_{GS} = 0\text{V}$ to $5\text{V}$		-	68	81	nC
Threshold Gate Charge	$Q_{g(TH)}$	$V_{GS} = 0\text{V}$ to $1\text{V}$		-	5	6	nC
Gate to Source Gate Charge	$Q_{gs}$			-	14	-	nC
Gate to Drain "Miller" Charge	$Q_{gd}$			-	30	-	nC
<b>CAPACITANCE SPECIFICATIONS</b>							
Input Capacitance	$C_{ISS}$	$V_{DS} = 25\text{V}$ , $V_{GS} = 0\text{V}$ , $f = 1\text{MHz}$ (Figure 13)	-	4965	-	pF	
Output Capacitance	$C_{OSS}$		-	1250	-	pF	
Reverse Transfer Capacitance	$C_{RSS}$		-	150	-	pF	

## Source to Drain Diode Specifications

PARAMETER	SYMBOL	TEST CONDITIONS	MIN	TYP	MAX	UNITS
Source to Drain Diode Voltage	$V_{SD}$	$I_{SD} = 75\text{A}$	-	-	1.25	V
		$I_{SD} = 35\text{A}$	-	-	1.00	V
Reverse Recovery Time	$t_{rr}$	$I_{SD} = 75\text{A}$ , $dI_{SD}/dt = 100\text{A}/\mu\text{s}$	-	-	100	ns
Reverse Recovered Charge	$Q_{RR}$	$I_{SD} = 75\text{A}$ , $dI_{SD}/dt = 100\text{A}/\mu\text{s}$	-	-	260	nC

Typical Performance Curves

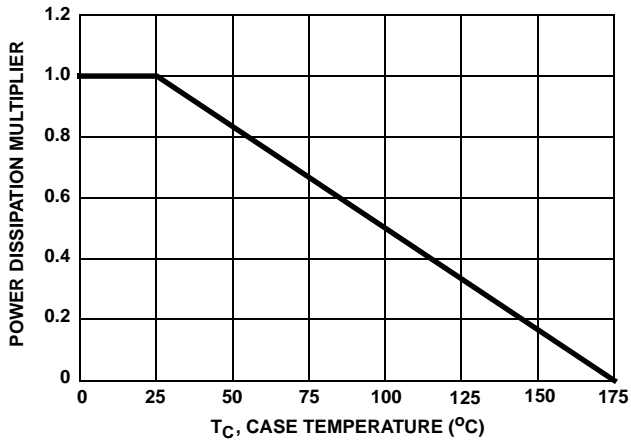

FIGURE 1. NORMALIZED POWER DISSIPATION vs CASE TEMPERATURE

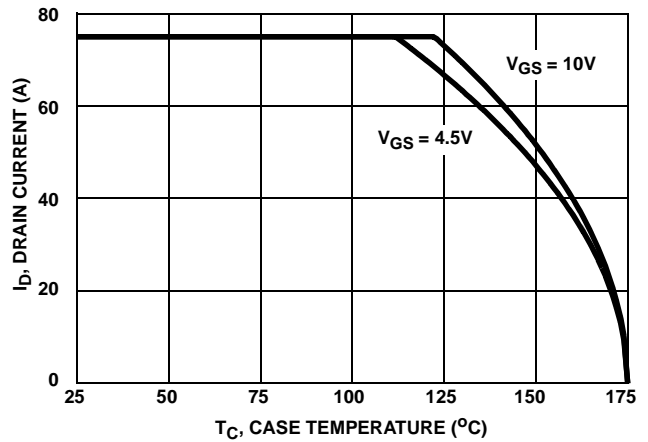

FIGURE 2. MAXIMUM CONTINUOUS DRAIN CURRENT vs CASE TEMPERATURE

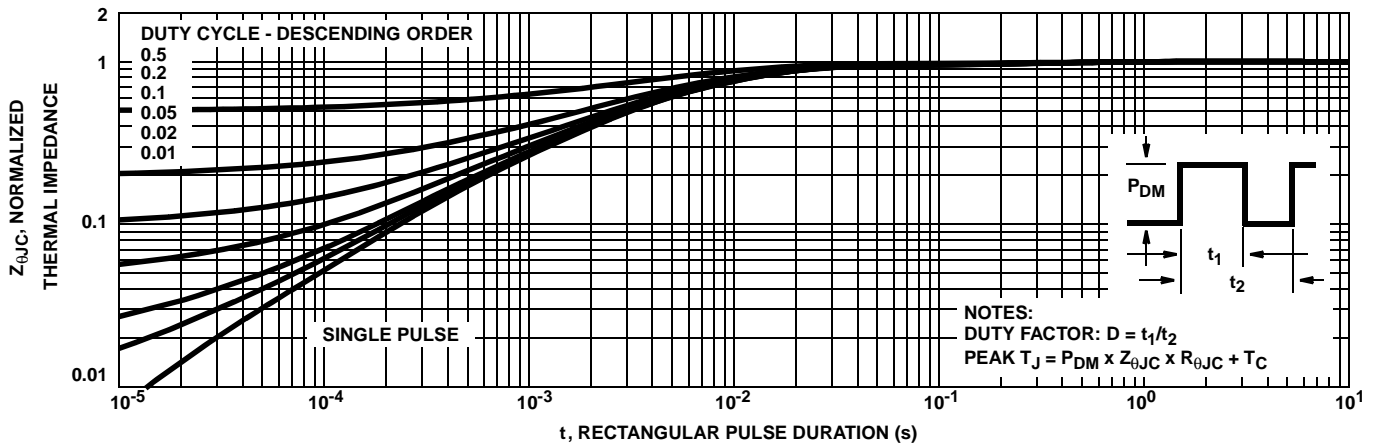

FIGURE 3. NORMALIZED MAXIMUM TRANSIENT THERMAL IMPEDANCE

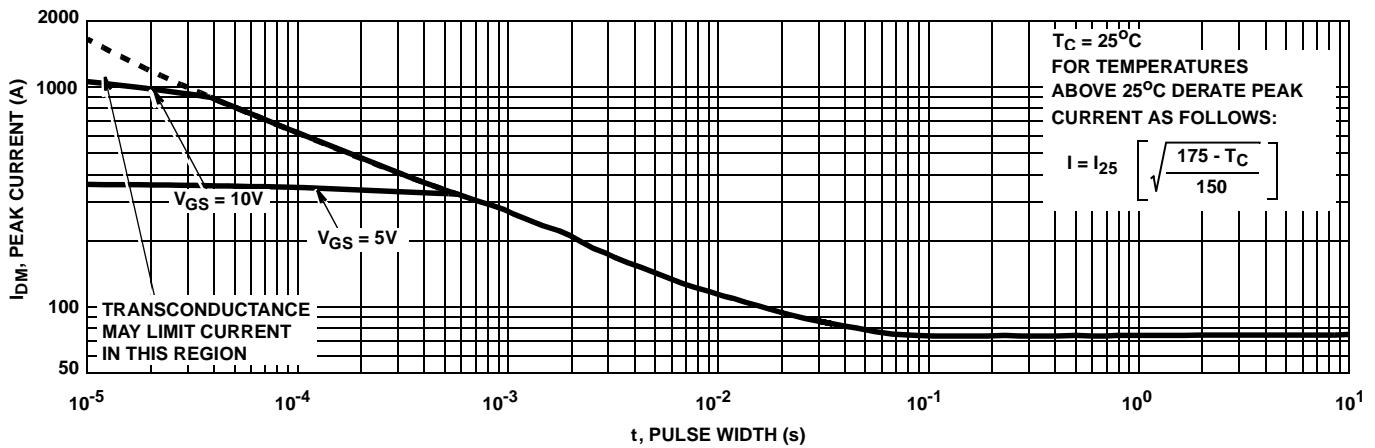

FIGURE 4. PEAK CURRENT CAPABILITY

Typical Performance Curves (Continued)

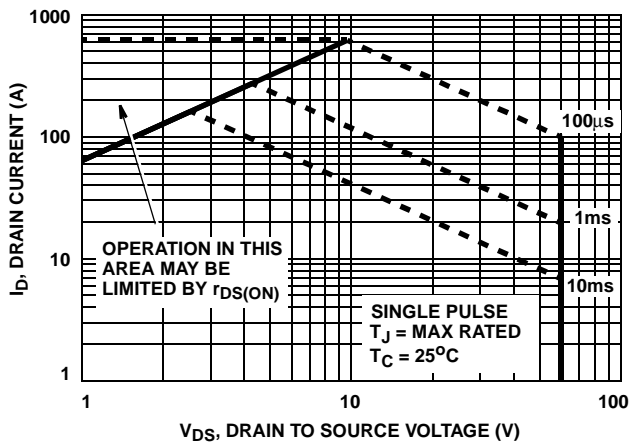
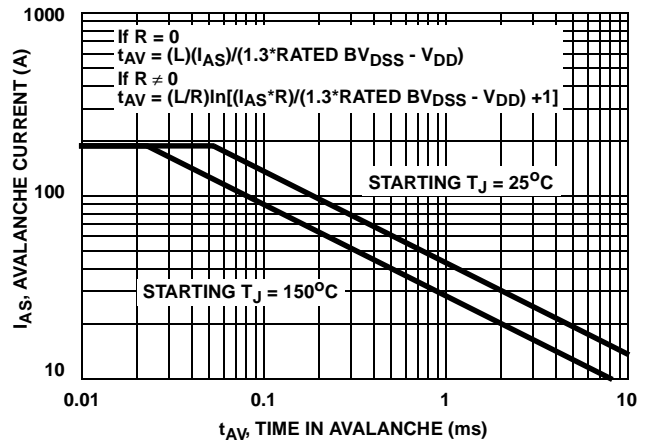

FIGURE 5. FORWARD BIAS SAFE OPERATING AREA



NOTE: Refer to Fairchild Application Notes AN9321 and AN9322.

FIGURE 6. UNCLAMPED INDUCTIVE SWITCHING CAPABILITY

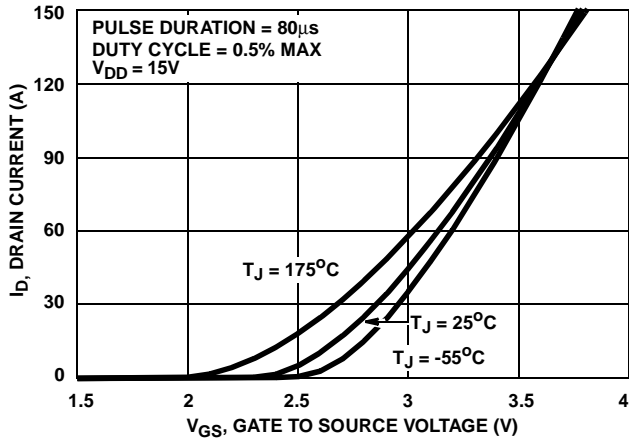

FIGURE 7. TRANSFER CHARACTERISTICS

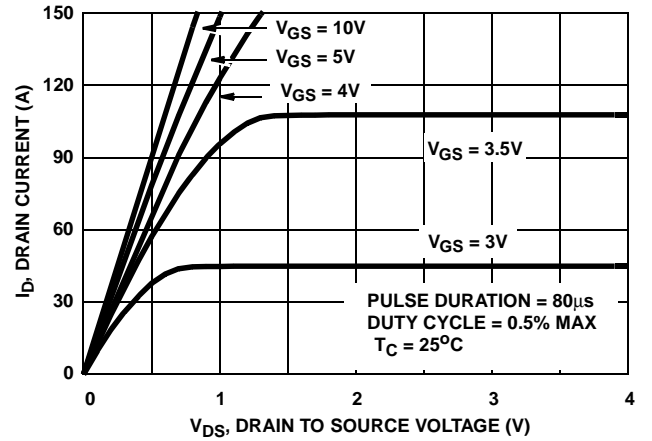

FIGURE 8. SATURATION CHARACTERISTICS

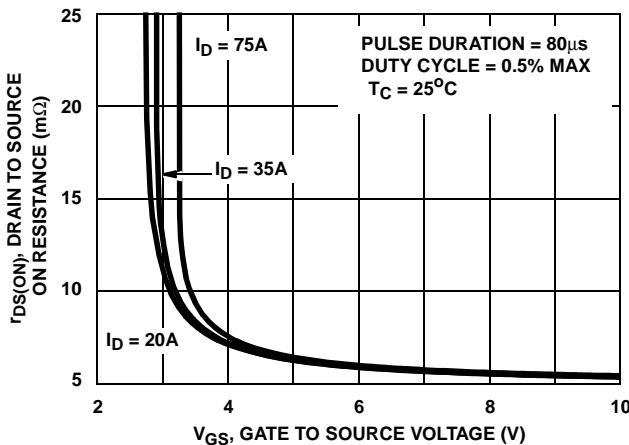

FIGURE 9. DRAIN TO SOURCE ON RESISTANCE vs. GATE VOLTAGE AND DRAIN CURRENT

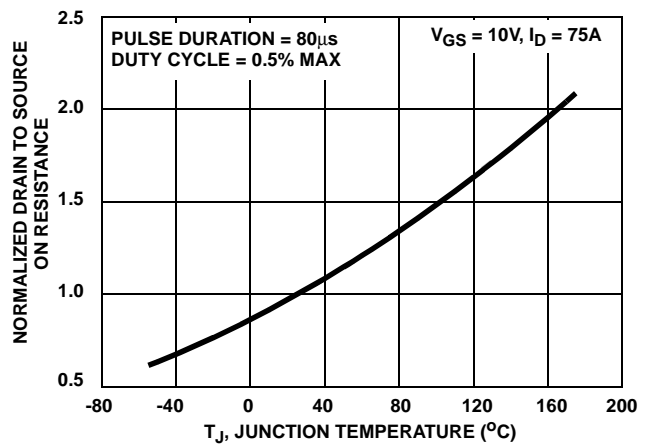

FIGURE 10. NORMALIZED DRAIN TO SOURCE ON RESISTANCE vs. JUNCTION TEMPERATURE

Typical Performance Curves (Continued)

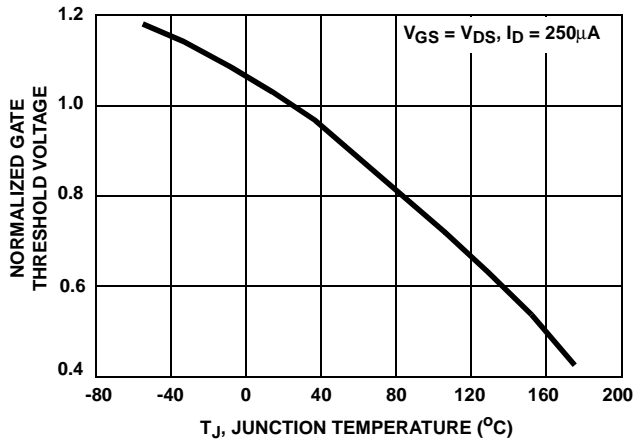

FIGURE 11. NORMALIZED GATE THRESHOLD VOLTAGE vs JUNCTION TEMPERATURE

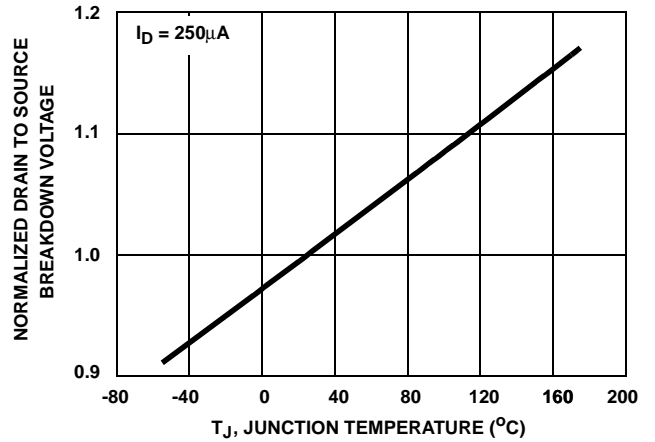

FIGURE 12. NORMALIZED DRAIN TO SOURCE BREAKDOWN VOLTAGE vs JUNCTION TEMPERATURE

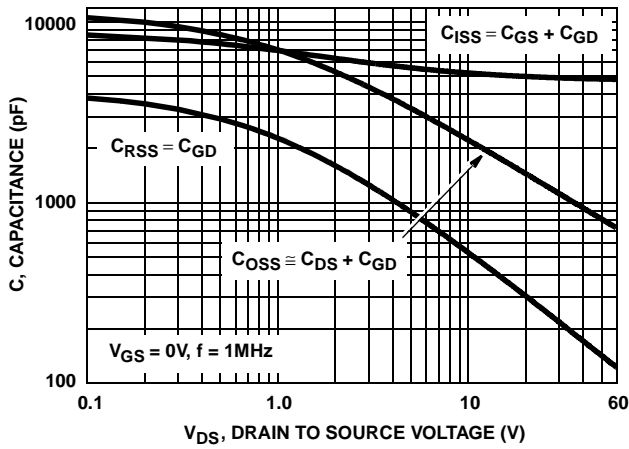
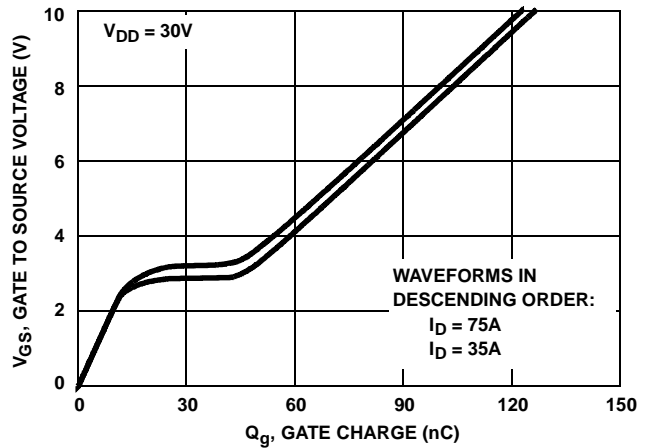

FIGURE 13. CAPACITANCE vs DRAIN TO SOURCE VOLTAGE



NOTE: Refer to Fairchild Application Notes AN7254 and AN7260.

FIGURE 14. GATE CHARGE WAVEFORMS FOR CONSTANT GATE CURRENT

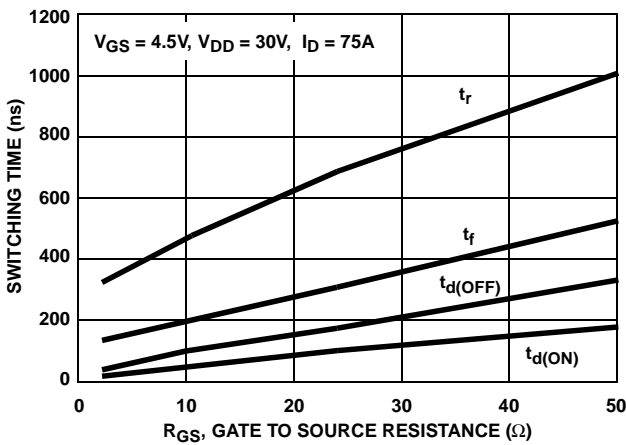

FIGURE 15. SWITCHING TIME vs GATE RESISTANCE

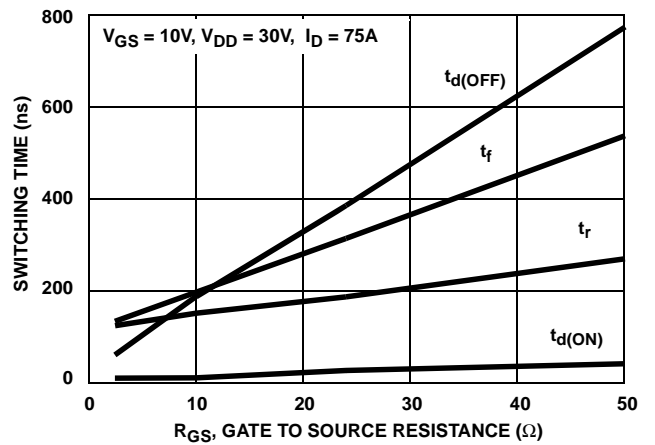

FIGURE 16. SWITCHING TIME vs GATE RESISTANCE

Test Circuits and Waveforms



FIGURE 17. UNCLAMPED ENERGY TEST CIRCUIT



FIGURE 18. UNCLAMPED ENERGY WAVEFORMS



FIGURE 19. GATE CHARGE TEST CIRCUIT

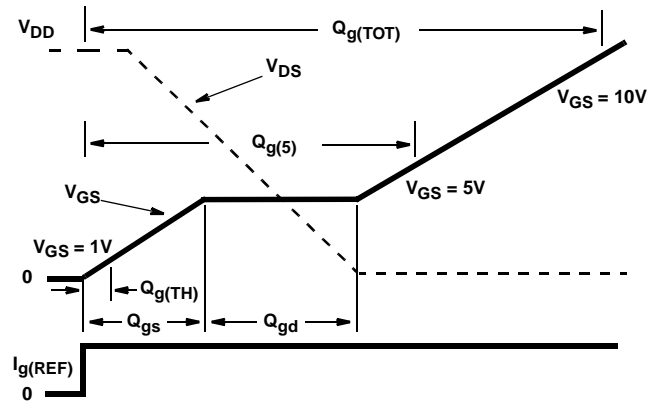

FIGURE 20. GATE CHARGE WAVEFORMS



FIGURE 21. SWITCHING TIME TEST CIRCUIT



FIGURE 22. SWITCHING TIME WAVEFORM

# HUF76445P3, HUF76445S3S

## PSPICE Electrical Model

.SUBCKT HUF76445 2 1 3 ; rev 23 April1999

CA 12 8 6.50e-9  
 CB 15 14 6.50e-9  
 CIN 6 8 4.71e-9

DBODY 7 5 DBODYMOD  
 DBREAK 5 11 DBREAKMOD  
 DPLCAP 10 5 DPLCAPMOD

EBREAK 11 7 17 18 66.30  
 EDS 14 8 5 8 1  
 EGS 13 8 6 8 1  
 ESG 6 10 6 8 1  
 EVTHRES 6 21 19 8 1  
 EVTEMP 20 6 18 22 1

IT 8 17 1

LDRAIN 2 5 1e-9  
 LGATE 1 9 5.05e-9  
 LSOURCE 3 7 2.64e-9

MMED 16 6 8 8 MMEDMOD  
 MSTRO 16 6 8 8 MSTROMOD  
 MWEAK 16 21 8 8 MWEAKMOD

RBREAK 17 18 RBREAKMOD 1  
 RDRAIN 50 16 RDRAINMOD 1.90e-3  
 RGATE 9 20 0.87  
 RLDRAIN 2 5 10  
 RLGATE 1 9 50.5  
 RLSOURCE 3 7 26.4  
 RSLC1 5 51 RSLCMOD 1e-6  
 RSLC2 5 50 1e3  
 RSOURCE 8 7 RSOURCEMOD 3.0e-3  
 RVTHRES 22 8 RVTHRESMOD 1  
 RVTEMP 18 19 RVTEMPMOD 1

S1A 6 12 13 8 S1AMOD  
 S1B 13 12 13 8 S1BMOD  
 S2A 6 15 14 13 S2AMOD  
 S2B 13 15 14 13 S2BMOD

VBAT 22 19 DC 1

ESLC 51 50 VALUE={(V(5,51)/ABS(V(5,51)))\*(PWR(V(5,51))/(1e-6\*453),3))}

.MODEL DBODYMOD D (IS = 4.45e-12 RS = 2.08e-3 TRS1 = 1.75e-3 TRS2 = 1.03e-6 CJO = 7.22e-9 TT = 7.21e-8 M = 0.60)  
 .MODEL DBREAKMOD D (RS = 1.23e-1 TRS1 = 0 TRS2 = 0)  
 .MODEL DPLCAPMOD D (CJO = 4.13e-9 IS = 1e-3 0Vj = 1.0 M = 0.85)  
 .MODEL MMEDMOD NMOS (VTO = 1.90 KP = 5.0 IS = 1e-30 N = 10 TOX = 1 L = 1u W = 1u RG = 0.87)  
 .MODEL MSTROMOD NMOS (VTO = 2.31 KP = 275 IS = 1e-30 N = 10 TOX = 1 L = 1u W = 1u)  
 .MODEL MWEAKMOD NMOS (VTO = 1.65 KP = 0.12 IS = 1e-30 N = 10 TOX = 1 L = 1u W = 1u RG = 8.7 RS = 0.1)  
 .MODEL RBREAKMOD RES (TC1 = 1.16e-3 TC2 = 1.17e-7)  
 .MODEL RDRAINMOD RES (TC1 = 1.48e-2 TC2 = 2.93e-5)  
 .MODEL RSLCMOD RES (TC1 = 1.53e-3 TC2 = 0)  
 .MODEL RSOURCEMOD RES (TC1 = 0 TC2 = 0)  
 .MODEL RVTHRESMOD RES (TC1 = -2.87e-3 TC2 = -1.02e-5)  
 .MODEL RVTEMPMOD RES (TC1 = -1.42e-3 TC2 = 9.21e-7)

.MODEL S1AMOD VSWITCH (RON = 1e-5 ROFF = 0.1 VON = -5.7 VOFF = -2.7)  
 .MODEL S1BMOD VSWITCH (RON = 1e-5 ROFF = 0.1 VON = -2.7 VOFF = -5.7)  
 .MODEL S2AMOD VSWITCH (RON = 1e-5 ROFF = 0.1 VON = -1.0 VOFF = 0.5)  
 .MODEL S2BMOD VSWITCH (RON = 1e-5 ROFF = 0.1 VON = 0.5 VOFF = -1.0)

.ENDS

NOTE: For further discussion of the PSPICE model, consult **A New PSPICE Sub-Circuit for the Power MOSFET Featuring Global Temperature Options**; IEEE Power Electronics Specialist Conference Records, 1991, written by William J. Hepp and C. Frank Wheatley.

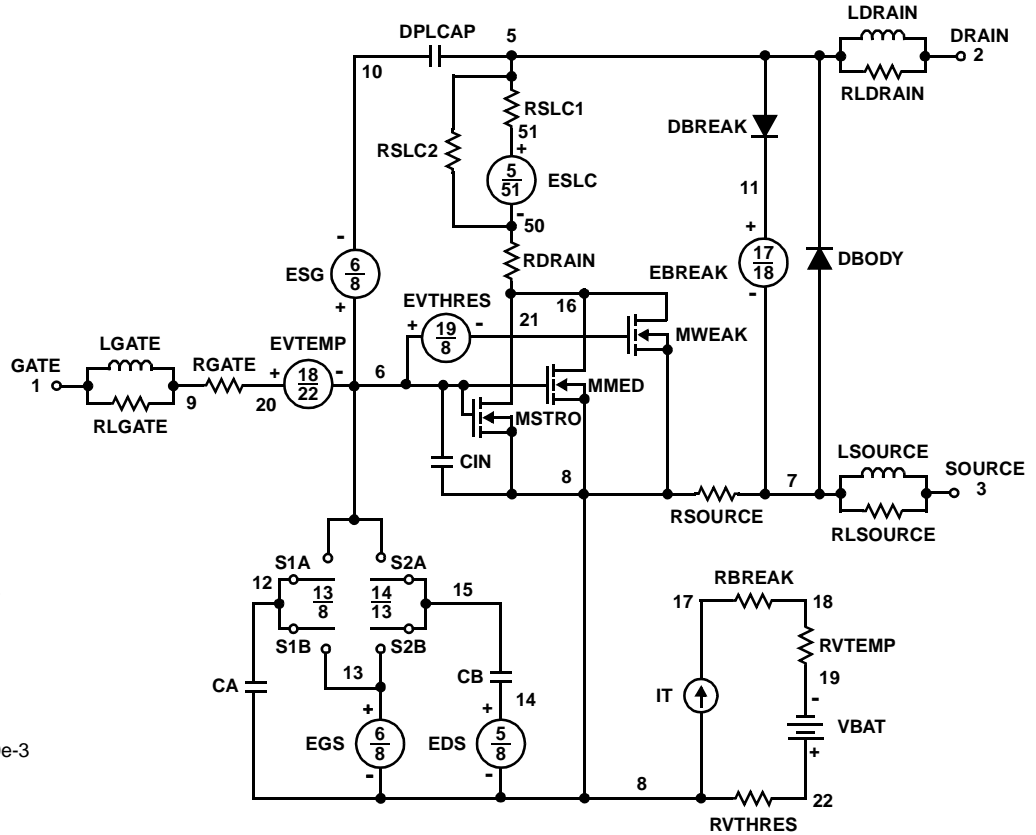





**SPICE Thermal Model**

REV 8 April 1999

HUF76445T

CTHERM1 th 6 6.45e-3  
 CTHERM2 6 5 3.00e-2  
 CTHERM3 5 4 1.40e-2  
 CTHERM4 4 3 1.65e-2  
 CTHERM5 3 2 4.85e-2  
 CTHERM6 2 tl 12.55

RTHERM1 th 6 3.24e-3  
 RTHERM2 6 5 8.08e-3  
 RTHERM3 5 4 2.28e-2  
 RTHERM4 4 3 1.28e-1  
 RTHERM5 3 2 1.93e-1  
 RTHERM6 2 tl 2.56e-2

**SABER Thermal Model**

SABER thermal model HUF76445T

```

template thermal_model th tl
thermal_c th, tl
{
ctherm.ctherm1 th 6 = 6.45e-3
ctherm.ctherm2 6 5 = 3.00e-2
ctherm.ctherm3 5 4 = 1.40e-2
ctherm.ctherm4 4 3 = 1.65e-2
ctherm.ctherm5 3 2 = 4.85e-2
ctherm.ctherm6 2 tl = 12.55

rtherm.rtherm1 th 6 = 3.24e-3
rtherm.rtherm2 6 5 = 8.08e-3
rtherm.rtherm3 5 4 = 2.28e-2
rtherm.rtherm4 4 3 = 1.28e-1
rtherm.rtherm5 3 2 = 1.93e-1
rtherm.rtherm6 2 tl = 2.56e-2
}
    
```

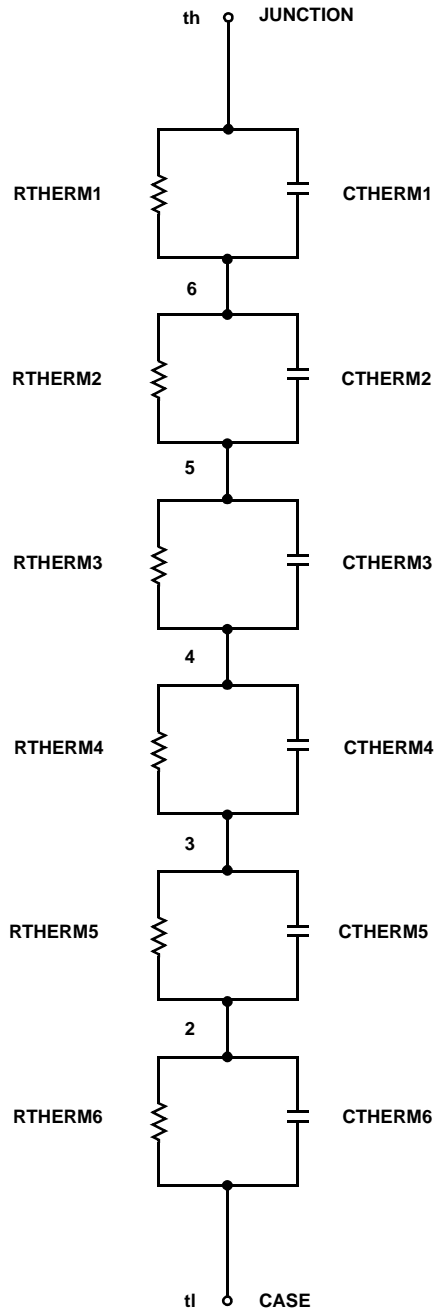

## TRADEMARKS

The following are registered and unregistered trademarks Fairchild Semiconductor owns or is authorized to use and is not intended to be an exhaustive list of all such trademarks.

ACE <sub>x</sub> <sup>TM</sup>	FAST <sup>®</sup>	OPTOLOGIC <sup>TM</sup>	SMART START <sup>TM</sup>	VCX <sup>TM</sup>
Bottomless <sup>TM</sup>	FAST <sub>r</sub> <sup>TM</sup>	OPTOPLANAR <sup>TM</sup>	STAR*POWER <sup>TM</sup>	
CoolFET <sup>TM</sup>	FRFET <sup>TM</sup>	PACMAN <sup>TM</sup>	Stealth <sup>TM</sup>	
CROSSVOLT <sup>TM</sup>	GlobalOptoisolator <sup>TM</sup>	POP <sup>TM</sup>	SuperSOT <sup>TM</sup> -3	
DenseTrench <sup>TM</sup>	GTO <sup>TM</sup>	Power247 <sup>TM</sup>	SuperSOT <sup>TM</sup> -6	
DOMET <sup>TM</sup>	HiSeC <sup>TM</sup>	PowerTrench <sup>®</sup>	SuperSOT <sup>TM</sup> -8	
EcoSPARK <sup>TM</sup>	ISOPLANAR <sup>TM</sup>	QFET <sup>TM</sup>	SyncFET <sup>TM</sup>	
E <sup>2</sup> CMOS <sup>TM</sup>	LittleFET <sup>TM</sup>	QST <sup>TM</sup>	TinyLogic <sup>TM</sup>	
EnSigna <sup>TM</sup>	MicroFET <sup>TM</sup>	QT Optoelectronics <sup>TM</sup>	TruTranslation <sup>TM</sup>	
FACT <sup>TM</sup>	MicroPak <sup>TM</sup>	Quiet Series <sup>TM</sup>	UHC <sup>TM</sup>	
FACT Quiet Series <sup>TM</sup>	MICROWIRE <sup>TM</sup>	SILENT SWITCHER <sup>®</sup>	UltraFET <sup>®</sup>	

STAR\*POWER is used under license

## DISCLAIMER

FAIRCHILD SEMICONDUCTOR RESERVES THE RIGHT TO MAKE CHANGES WITHOUT FURTHER NOTICE TO ANY PRODUCTS HEREIN TO IMPROVE RELIABILITY, FUNCTION OR DESIGN. FAIRCHILD DOES NOT ASSUME ANY LIABILITY ARISING OUT OF THE APPLICATION OR USE OF ANY PRODUCT OR CIRCUIT DESCRIBED HEREIN; NEITHER DOES IT CONVEY ANY LICENSE UNDER ITS PATENT RIGHTS, NOR THE RIGHTS OF OTHERS.

## LIFE SUPPORT POLICY

FAIRCHILD'S PRODUCTS ARE NOT AUTHORIZED FOR USE AS CRITICAL COMPONENTS IN LIFE SUPPORT DEVICES OR SYSTEMS WITHOUT THE EXPRESS WRITTEN APPROVAL OF FAIRCHILD SEMICONDUCTOR CORPORATION.

As used herein:

1. Life support devices or systems are devices or systems which, (a) are intended for surgical implant into the body, or (b) support or sustain life, or (c) whose failure to perform when properly used in accordance with instructions for use provided in the labeling, can be reasonably expected to result in significant injury to the user.
2. A critical component is any component of a life support device or system whose failure to perform can be reasonably expected to cause the failure of the life support device or system, or to affect its safety or effectiveness.

## PRODUCT STATUS DEFINITIONS

### Definition of Terms

Datasheet Identification	Product Status	Definition
Advance Information	Formative or In Design	This datasheet contains the design specifications for product development. Specifications may change in any manner without notice.
Preliminary	First Production	This datasheet contains preliminary data, and supplementary data will be published at a later date. Fairchild Semiconductor reserves the right to make changes at any time without notice in order to improve design.
No Identification Needed	Full Production	This datasheet contains final specifications. Fairchild Semiconductor reserves the right to make changes at any time without notice in order to improve design.
Obsolete	Not In Production	This datasheet contains specifications on a product that has been discontinued by Fairchild semiconductor. The datasheet is printed for reference information only.