

## Low Dropout Voltage Regulator

### ■ GENERAL DESCRIPTION

The NJM2877 is a 150mA output low dropout voltage regulator with ON/OFF control.

Advanced Bipolar technology achieves low noise, high ripple rejection, High accuracy and low quiescent current.

Package line-up is very small package: SC88A and standard package: SOT23-5.

Small packaging and 0.47 $\mu$ F small decoupling capacitor make the NJM2877 suitable for space conscious applications.

### ■ PACKAGE OUTLINE

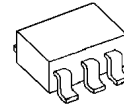

NJM2877F



NJM2877F3

### ■ FEATURES

- High Ripple Rejection      75dB typ. (f=1kHz Vo=3V version)
- Output Noise Voltage      Vno=30 $\mu$ Vrms typ. (Cp=0.01 $\mu$ F)
- Output capacitor with 0.47 $\mu$ F ceramic capacitor (Vo $\geq$ 2.7V Version)
- Output Current              Io(max.)=150mA
- High Precision Output      Vo  $\pm$ 1.0%
- Low Dropout Voltage      0.10V typ. (Io=60mA)
- ON/OFF Control              (Active High)
- Internal Thermal Overload Protection
- Internal Over Current Protection
- Bipolar Technology
- Package Outline              SC88A, SOT23-5

### ■ PIN CONFIGURATION

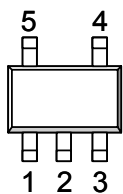

1. CONTROL
2. GND
3. NOISE BYPASS
4. V<sub>OUT</sub>
5. V<sub>IN</sub>

NJM2877F

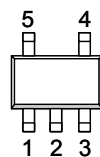

1. CONTROL
2. GND
3. NOISE BYPASS
4. V<sub>OUT</sub>
5. V<sub>IN</sub>

NJM2877F3

### ■ EQUIVALENT CIRCUIT

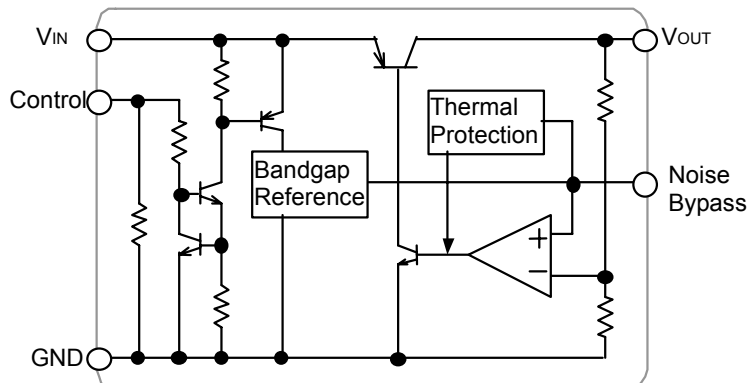

# NJM2877

## ■ OUTPUT VOLTAGE RANK LIST

### SC88A Package

Device Name	V <sub>out</sub>	Device Name	V <sub>out</sub>
NJM2877F3 -15	1.5V	NJM2877F3 -33	3.3V
NJM2877F3 -18	1.8V	NJM2877F3 -34	3.4V
NJM2877F3 -21	2.1V	NJM2877F3 -345	3.45V
NJM2877F3 -22	2.2V	NJM2877F3 -35	3.5V
NJM2877F3 -23	2.3V	NJM2877F3 -355	3.55V
NJM2877F3 -24	2.4V	NJM2877F3 -36	3.6V
NJM2877F3 -25	2.5V	NJM2877F3 -38	3.8V
NJM2877F3 -255	2.55V	NJM2877F3 -04	4.0V
NJM2877F3 -26	2.6V	NJM2877F3 -42	4.2V
NJM2877F3 -27	2.7V	NJM2877F3 -45	4.5V
NJM2877F3 -28	2.8V	NJM2877F3 -46	4.6V
NJM2877F3 -285	2.85V	NJM2877F3 -47	4.7V
NJM2877F3 -29	2.9V	NJM2877F3 -48	4.8V
NJM2877F3 -03	3.0V	NJM2877F3 -05	5.0V
NJM2877F3 -31	3.1V		
NJM2877F3 -32	3.2V		

### SOT23-5 Package

Device Name	V <sub>out</sub>
NJM2877F15	1.5V
NJM2877F28	2.8V
NJM2877F03	3.0V
NJM2877F33	3.3V
NJM2877F05	5.0V

## ■ ABSOLUTE MAXIMUM RATINGS (Ta=25°C)

PARAMETER	SYMBOL	RATINGS		UNIT
Input Voltage	V <sub>IN</sub>	+10		V
Control Voltage	V <sub>CONT</sub>	+10(*1)		V
Power Dissipation	P <sub>D</sub>	SC88A	250(*2)	mW
		SOT23-5	350(*2)	
			200(*3)	
Operating Temperature	T <sub>opr</sub>	-40 ~ +85		°C
Storage Temperature	T <sub>stg</sub>	-40 ~ +125		°C

(\*1): When input voltage is less than +10V, the absolute maximum control voltage is equal to the input voltage.

(\*2): Mounted on glass epoxy board based on EIA/JEDEC. (114.3 × 76.2 × 1.6mm: 2Layers FR-4)

(\*3): Device itself.

## ■ Operating voltage

V<sub>IN</sub>=+2.3 ~ +9V (In case of V<sub>o</sub><2.1V version)

## ■ ELECTRICAL CHARACTERISTICS

(V<sub>IN</sub>=V<sub>o</sub>+1V, C<sub>IN</sub>=0.1μF, C<sub>o</sub>=0.47μF: V<sub>o</sub>≥2.7V (C<sub>o</sub>=1.0μF : 1.8V<V<sub>o</sub>≤2.6V, C<sub>o</sub>=2.2μF : V<sub>o</sub>≤1.8V), C<sub>p</sub>=0.01μF, Ta=25°C)

PARAMETER	SYMBOL	TEST CONDITION	MIN.	TYP.	MAX.	UNIT
Output Voltage	V <sub>o</sub>	I <sub>o</sub> =30mA	-1.0%	-	+1.0%	V
Input Voltage	V <sub>IN</sub>		-	-	9	V
Quiescent Current	I <sub>Q</sub>	I <sub>o</sub> =0mA, except I <sub>cont</sub>	-	120	180	μA
Quiescent Current at Control OFF	I <sub>Q(OFF)</sub>	V <sub>CONT</sub> =0V	-	-	100	nA
Output Current	I <sub>o</sub>	V <sub>o</sub> - 0.3V	150	200	-	mA
Line Regulation	ΔV <sub>o</sub> /ΔV <sub>IN</sub>	V <sub>IN</sub> =V <sub>o</sub> +1V ~ V <sub>o</sub> +6V, I <sub>o</sub> =30mA	-	-	0.10	%/V
Load Regulation	ΔV <sub>o</sub> /ΔI <sub>o</sub>	I <sub>o</sub> =0 ~ 100mA	-	-	0.03	%/mA
Dropout Voltage (*4)	ΔV <sub>L-O</sub>	I <sub>o</sub> =60mA	-	0.10	0.18	V
Ripple Rejection	RR	e <sub>in</sub> =200mVrms, f=1kHz, I <sub>o</sub> =10mA, V <sub>o</sub> =3V version	-	75	-	dB
Average Temperature Coefficient of Output Voltage	ΔV <sub>o</sub> /ΔTa	Ta=0 ~ +85°C, I <sub>o</sub> =10mA	-	± 50	-	ppm/°C
Output Noise Voltage	V <sub>NO</sub>	f=10Hz~80kHz, I <sub>o</sub> =10mA, V <sub>o</sub> =3V Version	-	30	-	μVrms
Control Current	I <sub>CONT</sub>	V <sub>CONT</sub> =1.6V	-	3	12	μA
Control Voltage for ON-state	V <sub>CONT(ON)</sub>		1.6	-	-	V
Control Voltage for OFF-state	V <sub>CONT(OFF)</sub>		-	-	0.6	V

(\*4): The output voltage excludes under 2.1V.

The above specification is a common specification for all output voltages.

Therefore, it may be different from the individual specification for a specific output voltage.

# NJM2877

## TEST CIRCUIT

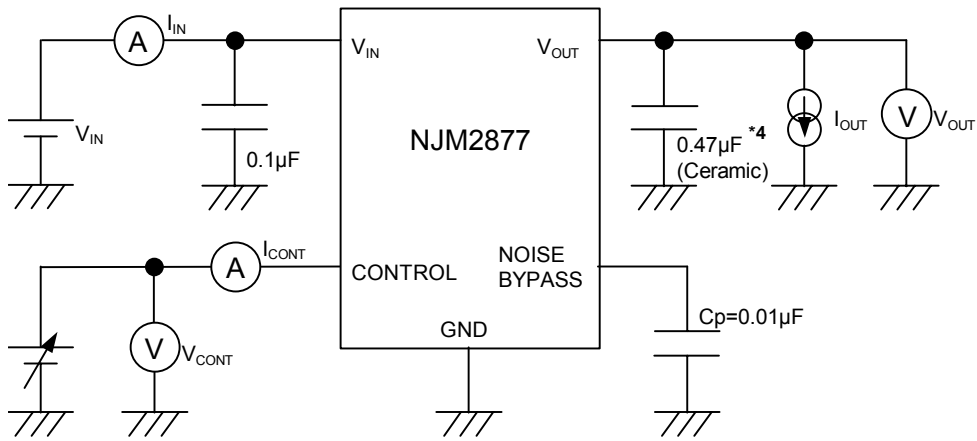

\*4: 1.8V <  $V_{O}$  ≤ 2.6V version:  $C_o = 1.0\mu\text{F}$  (Ceramic)  
 $V_{O} \leq 1.8\text{V}$  version:  $C_o = 2.2\mu\text{F}$  (Ceramic)

## TYPICAL APPLICATIONS

① In the case where ON/OFF Control is not required:

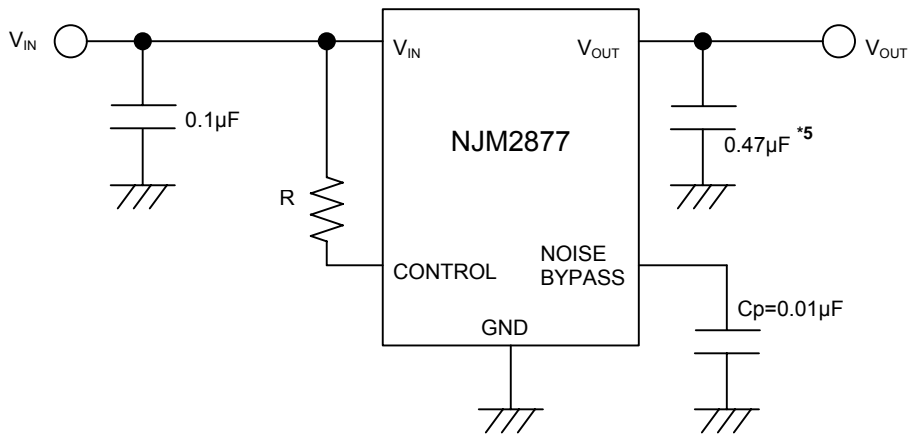

\*5: 1.8V <  $V_{O}$  ≤ 2.6V version:  $C_o = 1.0\mu\text{F}$   
 $V_{O} \leq 1.8\text{V}$  version:  $C_o = 2.2\mu\text{F}$

Connect control terminal to  $V_{IN}$  terminal

## ② In use of ON/OFF CONTROL:

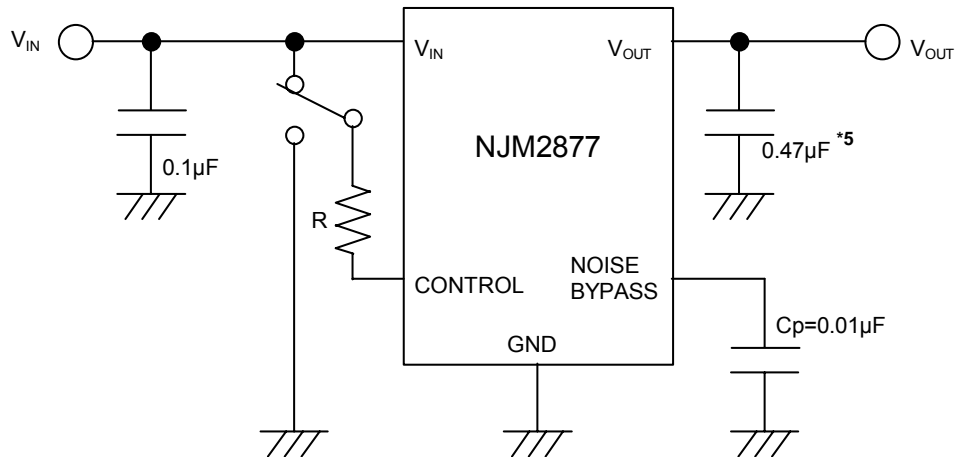

\*5 : 1.8V <  $V_o$  ≤ 2.6V version :  $C_o = 1.0\mu\text{F}$   
 $V_o \leq 1.8\text{V}$  version :  $C_o = 2.2\mu\text{F}$

State of control terminal:

- "H" → output is enabled.
- "L" or "open" → output is disabled.

### \*Noise bypass Capacitance $C_p$

Noise bypass capacitance  $C_p$  reduces noise generated by band-gap reference circuit.

Noise level and ripple rejection will be improved when larger  $C_p$  is used.

Use of smaller  $C_p$  value may cause oscillation.

Use the  $C_p$  value of  $0.01\mu\text{F}$  greater to avoid the problem.

### \*Input Capacitance $C_{IN}$

Input Capacitance  $C_{IN}$  is required to prevent oscillation and reduce power supply ripple for applications with high power supply impedance or a long power supply line.

Use the  $C_{IN}$  value of  $0.1\mu\text{F}$  greater to avoid the problem.

$C_{IN}$  should connect between GND and  $V_{IN}$  as short as possible.

### \*In the case of using a resistance "R" between $V_{IN}$ and control.

The current flow into the control terminal while the IC is ON state ( $I_{CONT}$ ) can be reduced when a pull up resistance "R" is inserted between  $V_{IN}$  and the control terminal.

The minimum control voltage for ON state ( $V_{CONT(ON)}$ ) is increased due to the voltage drop caused by  $I_{CONT}$  and the resistance "R". The  $I_{CONT}$  is temperature dependence as shown in the "Control Current vs. Temperature" characteristics. Therefore, the resistance "R" should be carefully selected to ensure the control voltage exceeds the  $V_{CONT(ON)}$  over the required temperature range.

## \*Output Capacitance Co

Output capacitor (Co) is required for a phase compensation of the internal error amplifier. The capacitance and the equivalent series resistance (ESR) influences stability of the regulator.

This product is designed to work with a low ESR capacitor for the Co; however, use of recommended capacitance or greater value is essential for stable operation.

Use of a smaller Co may cause excess output noise or oscillation of the regulator due to lack of the phase compensation.

Therefore, use Co with the recommended capacitance or greater value and connect between Vo terminal and GND terminal with minimal wiring. The recommended capacitance depends on the output voltage. Low voltage regulator requires greater value of the Co. Thus, check the recommended capacitance for each output voltage.

Use of a greater Co reduces output noise and ripple output, and also improves transient response of the output voltage against rapid load change.

## POWER DISSIPATION vs. AMBIENT TEMPERATURE (SC-88A)

NJM2877F3 Power Dissipation  
( $T_{opr}=-40\sim+85^{\circ}\text{C}$ ,  $T_j=125^{\circ}\text{C}$ )

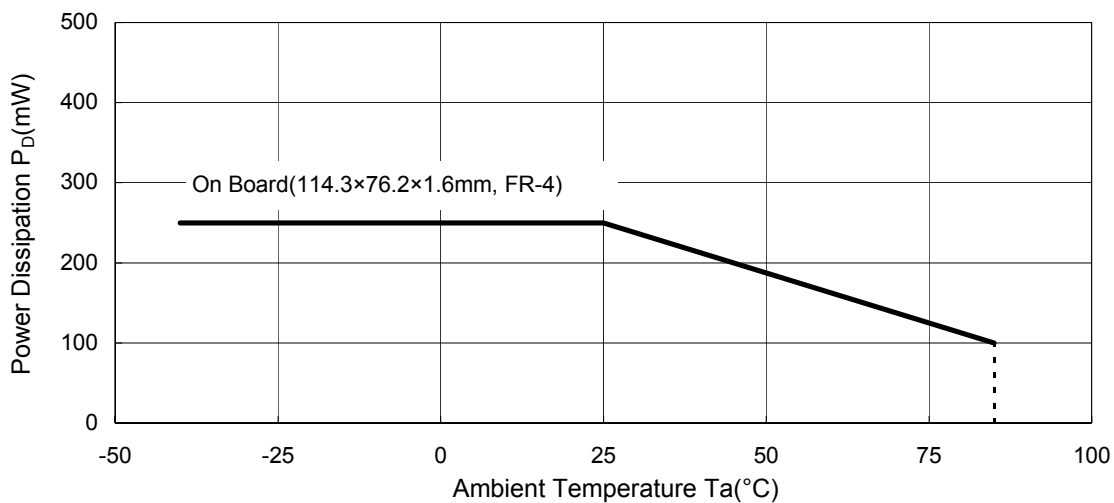

NJM2877F Power Dissipation  
( $T_{opr}=-40\sim+85^{\circ}\text{C}$ ,  $T_j=125^{\circ}\text{C}$ )

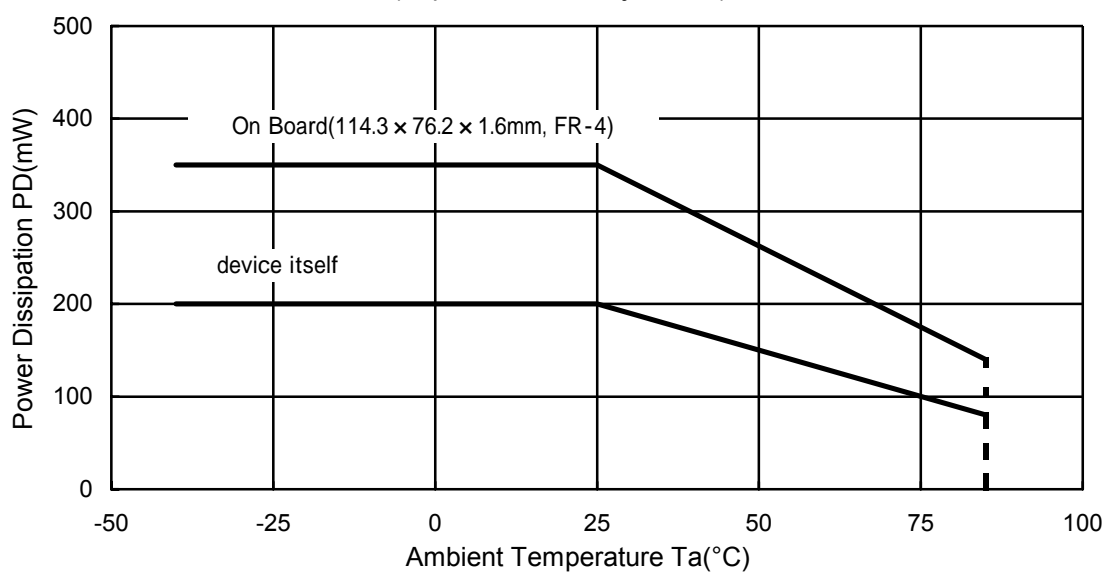

# NJM2877

## ■ TYPICAL CHARACTERISTICS

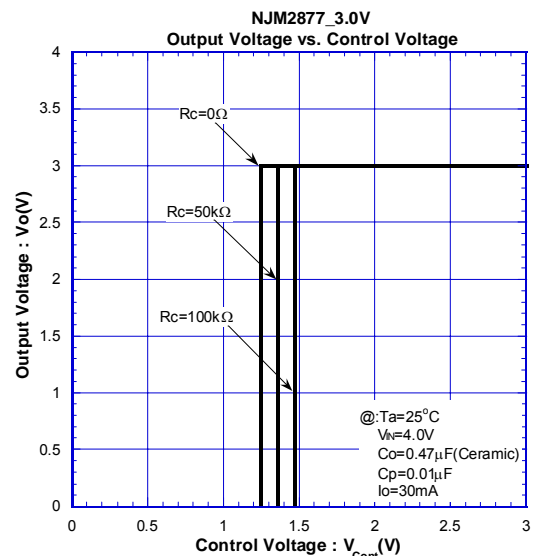
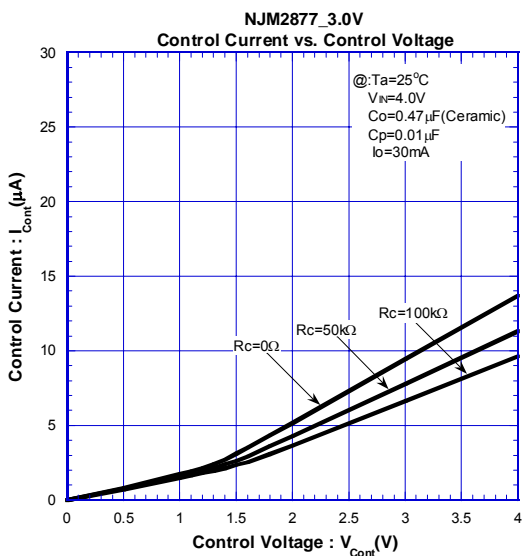
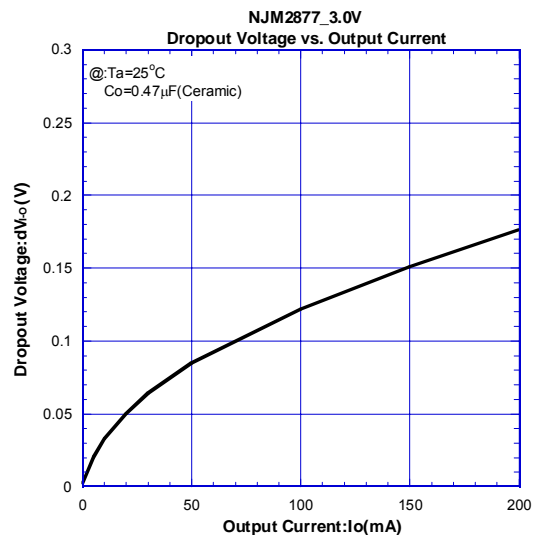
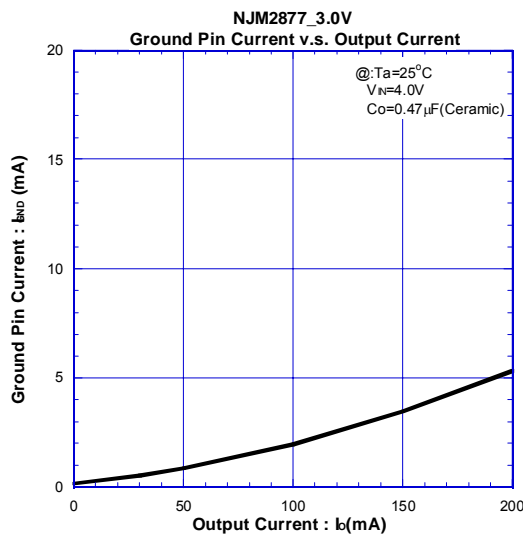
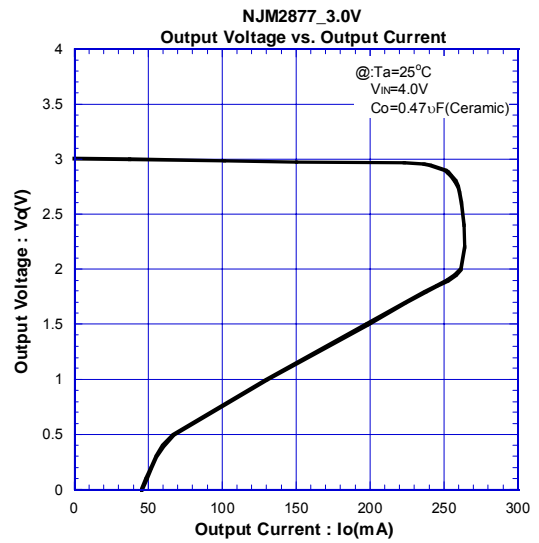
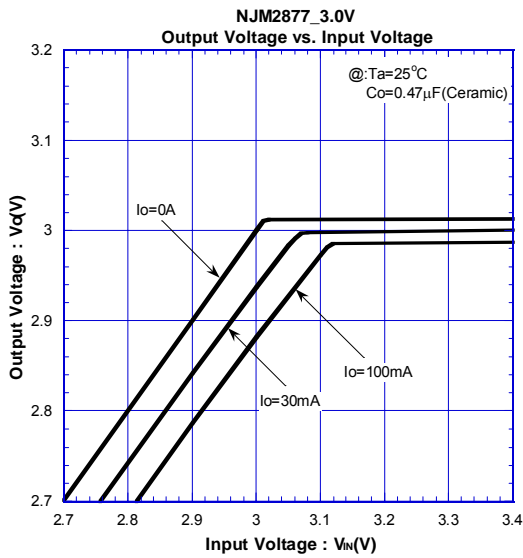



## ■ TYPICAL CHARACTERISTICS

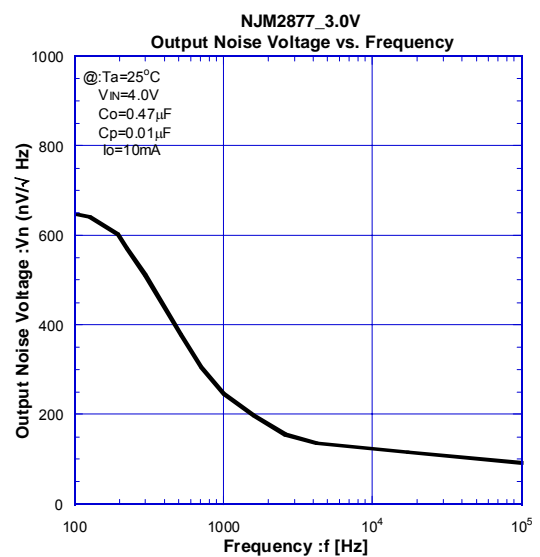
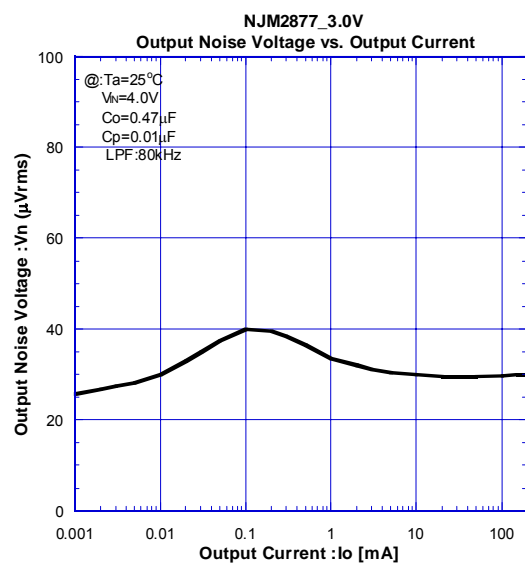
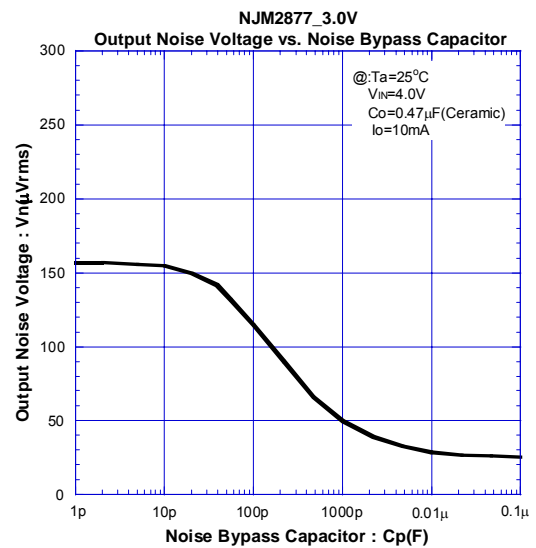
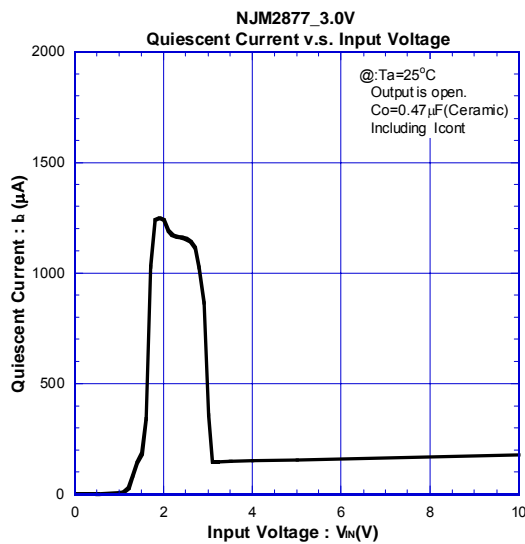
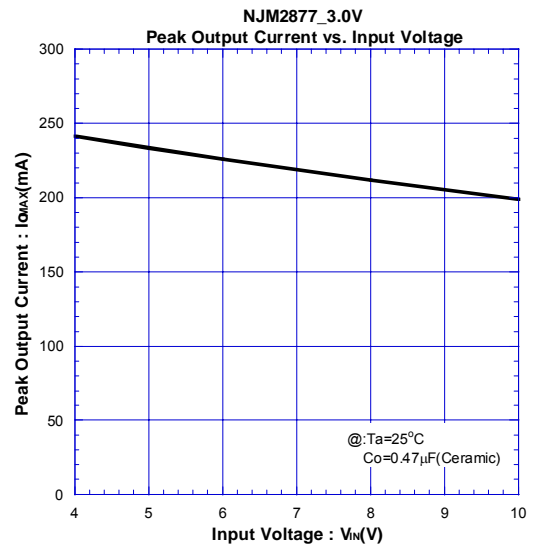
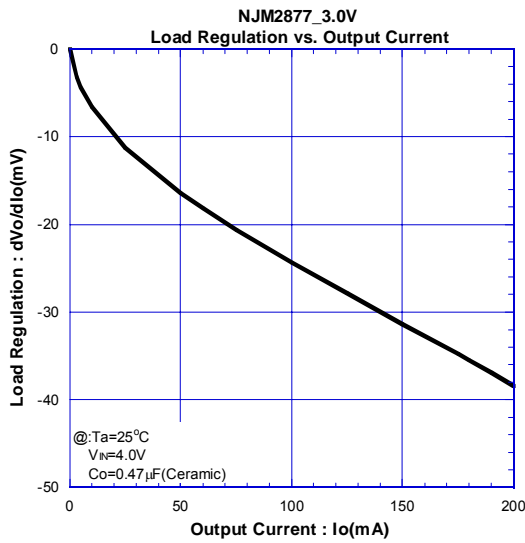

## ■ TYPICAL CHARACTERISTICS

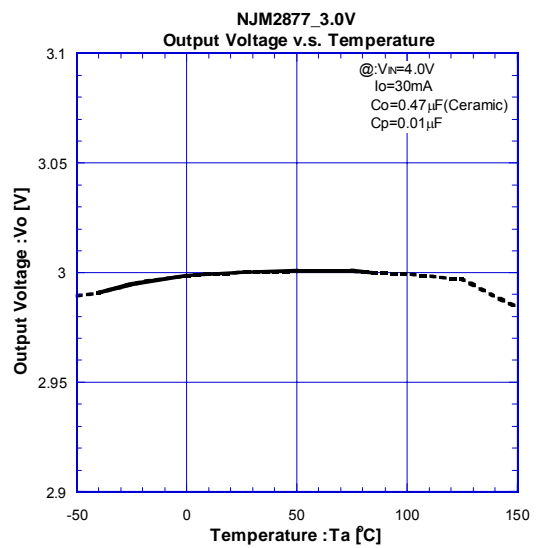
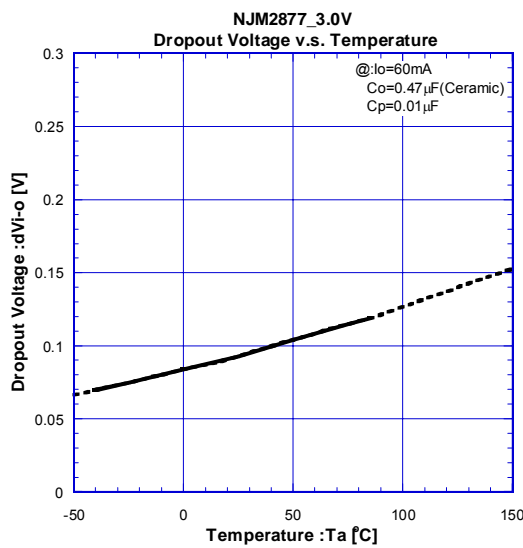
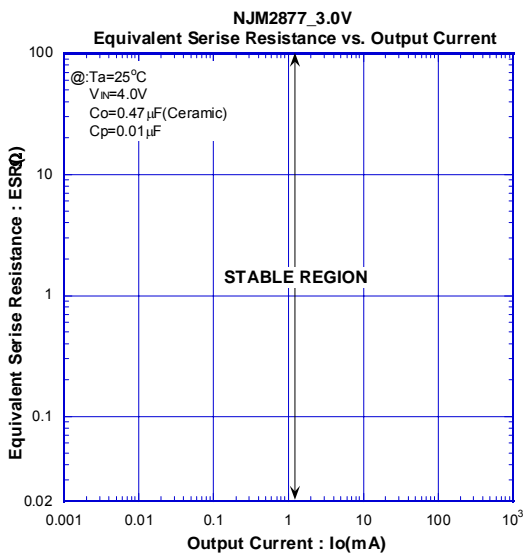
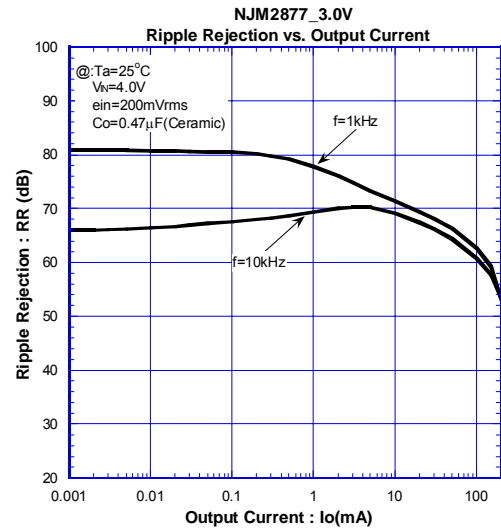
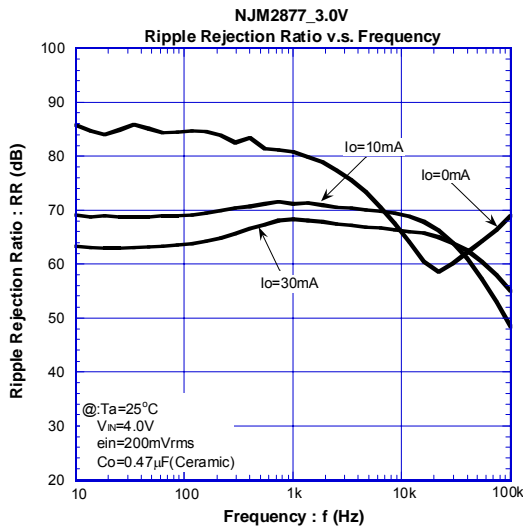

## TYPICAL CHARACTERISTICS

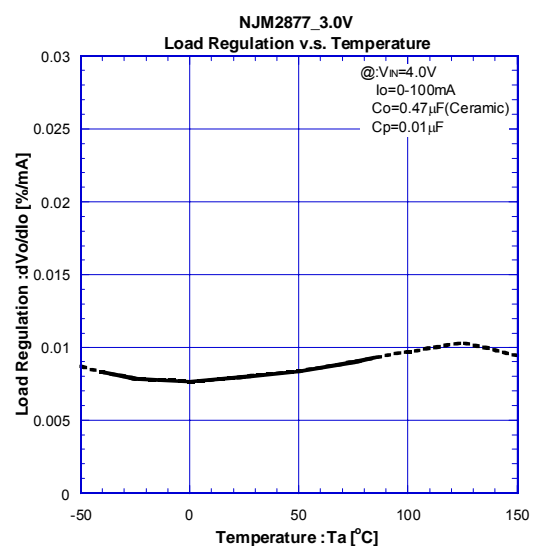
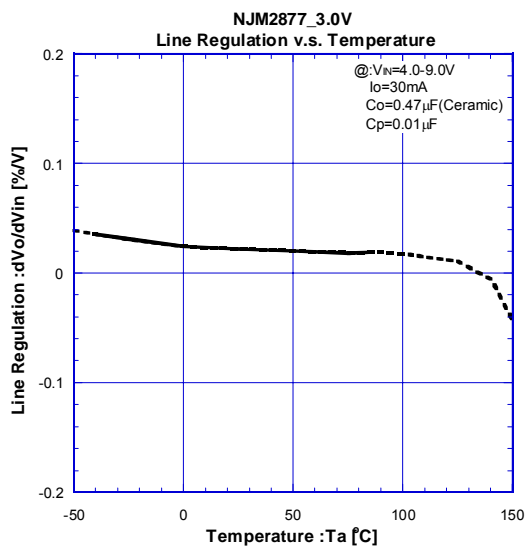
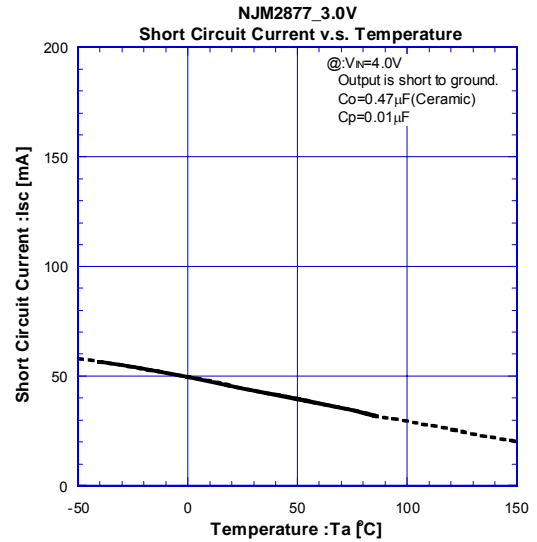
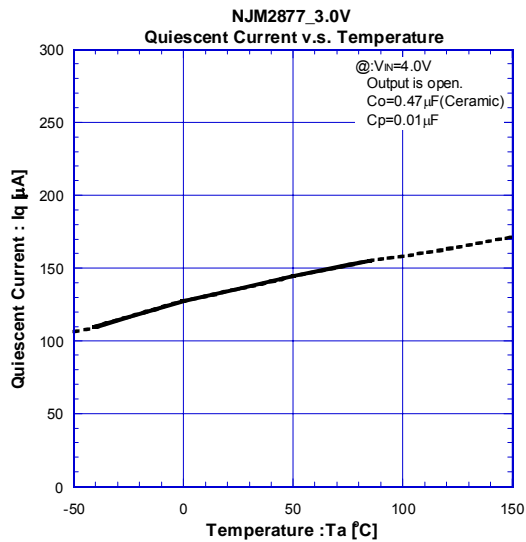
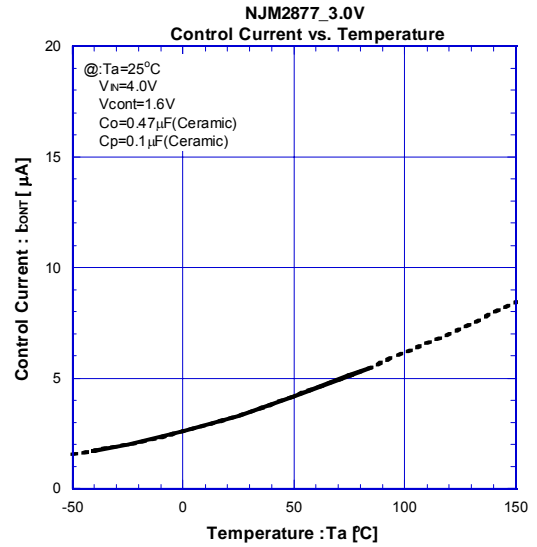
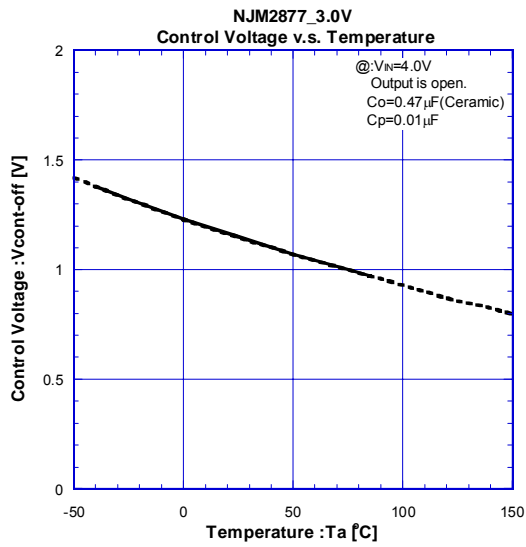

# NJM2877

## TYPICAL CHARACTERISTICS

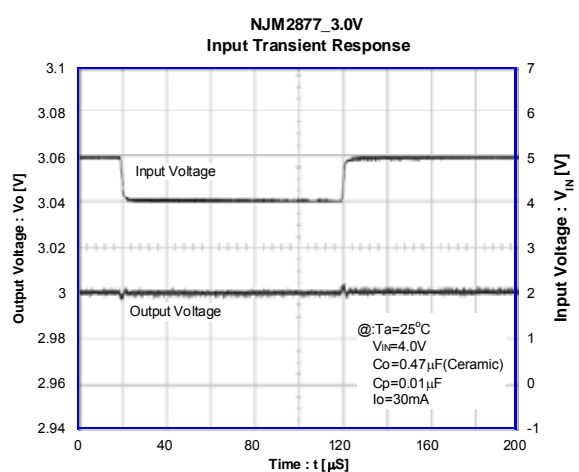
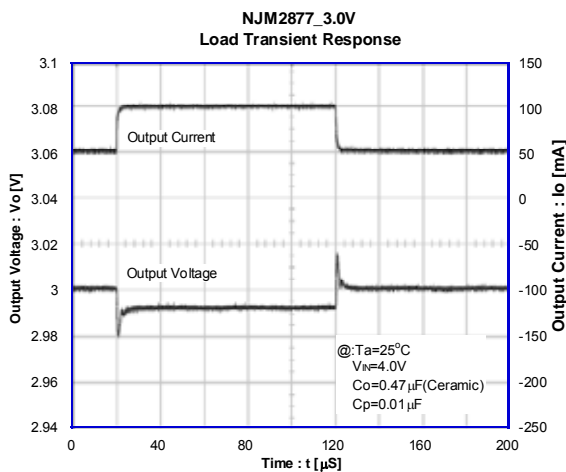
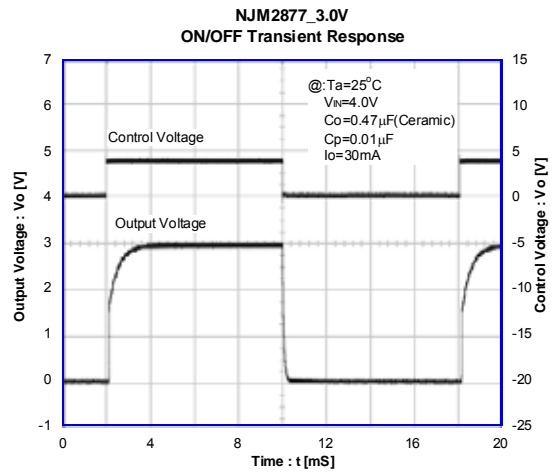
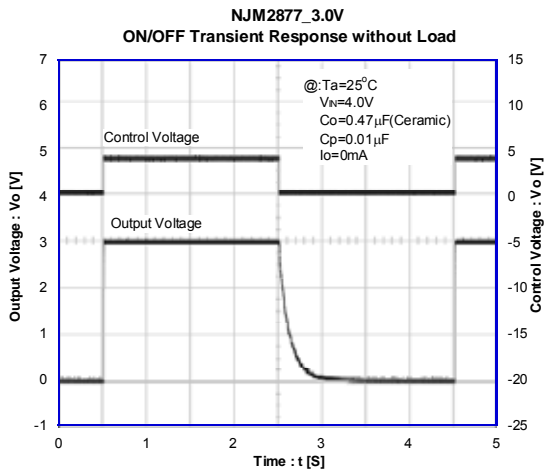
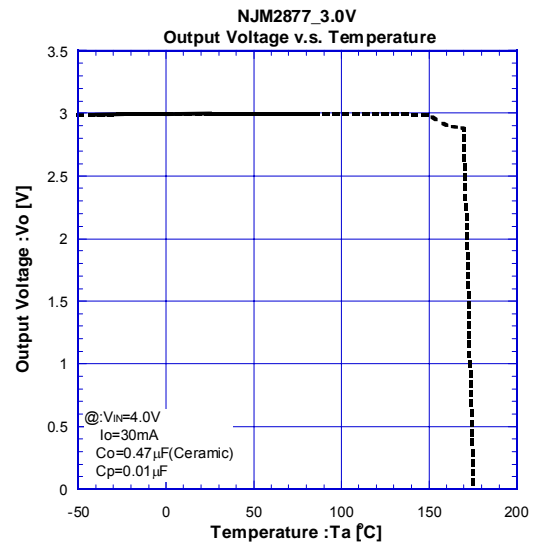
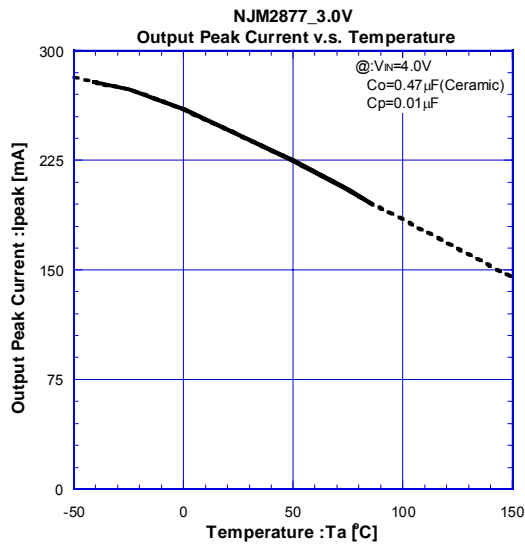

**[CAUTION]**

The specifications on this databook are only given for information, without any guarantee as regards either mistakes or omissions. The application circuits in this databook are described only to show representative usages of the product and not intended for the guarantee or permission of any right including the industrial rights.